



Z-II SERIES
Owner's Manual

Before operating the unit, please read this manual thoroughly and retain it for future reference.

MISSION STATEMENT

Committed to Excellence

ZAPCO is dedicated to the pursuit of audio fidelity. Our prime objectives are to design and manufacture audio products of unsurpassed quality, to provide unparalleled support and service for these products and to conduct business in a manner that will enhance the quality of life for all involved.

Experience (Knowledge from doing)

There is absolutely no substitute for experience; that is a simple fact of life. Another simple fact is that ZAPCO has, for over forty years, been the leader in defining quality standards for the car audio industry.

These years of experience have led to a thorough understanding of the challenges that are unique to the world of car audio. ZAPCO's relentless quest for sonic purity consistently yields imaginative designs that utilize the most innovative technologies. The resulting products set the criteria by which all others in the industry are judged.

Table of Contents

The new Zapco Z-Series Amplifiers	2
The re-birth of the Z-Series	2
Improved Circuit Board and Functionality Class AB	3
Improved Circuit Board and Functionality Class D	4
Before you start your Installation	5
Planning your Power Connections	6
Wire size	7
Mounting your Z-II Series Amplifier	8
The Z-II Class AB SQ Competition Amplifiers	9
Z-150.2 II Input and Controls	9
Z-150.4 II Input and Controls	10
Z-150.6 II Input and Controls	11
Z-150.2 II Speaker Wiring	12
Z-150.4 II Speaker Wiring	14
Z-150.6 II Speaker Wiring	17
The Z-II Class D SQ Competition Bass Amplifiers	20
Z-KD II Input and Controls	20
Z-KD II Speaker Wiring	22
Technical Specifications	24

The New Zapco Z-Series Amplifier

Congratulations, on the purchase of your new Zapco Z-Series amplifier. We believe you now have the finest sound available in a car sound amplifier, and we think you should know a little bit about what makes this amp unique in a world of so many so-so products.

The re-birth of the Z-Series

In 2012 Zapco introduced the new Z-Series of SQ amps. These amps were not conceived so much by our engineers, as by input from audiophiles and car sound fanatics around the world. Starting about 2004, at Zapco training seminars in Asia and in the EU, we began running into audiophiles who were changing certain internal components in our amplifiers to achieve what they felt was better quality sound.

With that in our minds, we developed the Z-Series amps with less measuring and more listening. So for the Z-Series of Zapco amplifiers, we experimented with internal components and new circuits to see if we could take our amps to the next level of sound quality by investing in different internal components and circuit designs, and the resulting Z-Series amps were the results of this unique development method.

Over the last years we have developed two specialized amplifiers to take auto sound to a different level. The Z-Series LX amp, the ultimate SQ amp. No controls except gain. A pure SQ amp. We also brought out the ZSP-Series amps for the fanatics that want to play full-volume full-time but still get audiophile sound.

This year we stepped back and took a look at the amp that started it all. The Z-Series amplifier. We knew we could bring the price down, because over the last few years. This allowed us to build the Z-series LX and amps cost only a little more than the original Z-Series so the prices weren't that far apart. Now we have brought the Z-Series into the same plant as the newer models. This saves money!

That lowers the price, but what could we do to make it better? We saw that a lot of the non-critical parts from the LX and amps could be used in the new Z-Series as well. Even with some of the SQ parts we save by buying more so we can use those in the Z-series also.

Bottom line, we have improved the amplifier at the same time we brought the price down. Who ever does that!

Of course, that's just talk, but here's the beef.

For the Class AB full range Competition Amps:

- A new TI op-amp that give the Z considerably better signal to noise ratio, with a lower floor noise
- We used the same audiophile grade caps that we use in the LX and amps
- We beefed up the power supply with more storage and less internal resistance and lower inductance for higher efficiency
- We added more MOSFETS to the power supply for efficiency and current handling

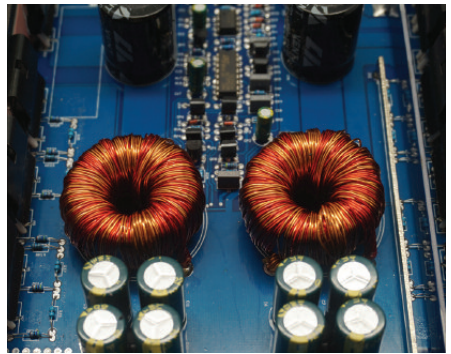
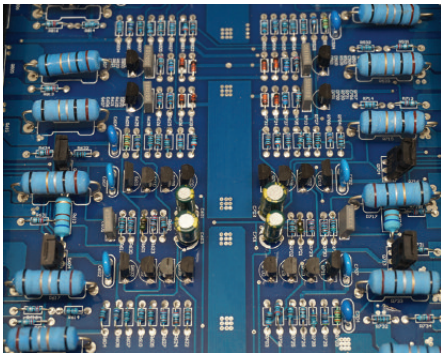

About functionality:

- The end plates are now recessed like the LX amps for a cleaner look
- The plastic controls have been replaced by new metal pots and switches. The new pots also have detents (like the amps) at 40ea so you can accurately set crossovers gains identical for right and left channels
- The new Z-II AB amps have band pass crossovers on all models so you won't need any outboard devices to make a band pass
- x-10 the multiplier switches from the amps are on the New Z to extend the crossover ranges. This means Z-150.2 II can have higher frequency crossover for a dedicated tweeter amp and the Z-150.6 II can do tweeter, midrange, and bass all with internal crossovers

- The new Z-Series amps have the same panel mount RCA connectors as the LX amps. Even the tightest RCA connector can't hurt them

For the Class D Competition Bass Amps:

The Z-II bass amps also get a number of improvements.

- A beefed up power supply
- Increased power
- New high end audio caps like the SQ amps
- New TI low noise op-amps like the SQ amps
- Improved tiffany style panel mount RCA connectors
- The end plates are now recessed like the LX amps for a cleaner look
- The plastic controls have been replaced by the new metal pots and switches. The new pots also have detents (like the SP amps) at 40ea so you can accurately set crossovers and gains identical with multiple amplifiers

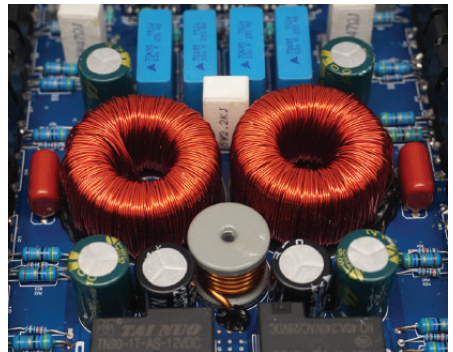
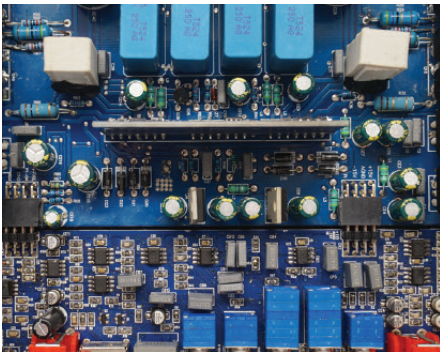

So there you are! Functionality improvements to make the amps more useful and sound quality improvements you'd never expect from a Class D bass amp.

Z-KD II; more useful, better looking and even better sounding.

Class A/B amps for full range use and Class D amps for bass. Whatever your needs, the new Zapco Z-II Competition series amplifiers bring you better features, better power, and better sound.

As we promised when we started: We will never re-paint an amp and call it a new model. Every run of amplifiers must be better than the last or we won't make it.

We sincerely hope you enjoy your new Z-II Series amplifier as much as we enjoyed the time we spent developing it.

Before you start your installation

ZAPCO highly recommends that a fuse or circuit breaker be placed within 18" of the battery. Although you will add a fuse or fuse block near the amplifier it is still a possibility that a pinched power wire between the component fuse and the battery could result in a short, or even a fire. The protection device should be placed where it can be accessed easily and all wiring should be routed safely and correctly according to the following guidelines:

Do not run wiring close to hot or spinning objects.

Always use wire grommets when routing wire through the firewall or any other metal panels.

Make sure that the potential for pinched wiring is avoided by routing all wires away from moving hinges and seats. This also includes brake, gas and clutch pedals, hood and trunk hinges, etc.

Continuous exposure to excessive sound pressure levels may cause permanent hearing loss. ZAPCO strongly advises that you use common sense when setting volume levels. If you experience ringing in the ears, it could cause permanent hearing damage!

When connecting our amplifiers to pre-wired stock speakers, care must be taken that there are no common connections between left and right speaker wires, i.e. two or more speakers using the same ground connection (very common in pre-85 cars), as this will cause the amplifier to go into immediate protection or may cause damage to the amplifier. Output connections are not common chassis ground. Please follow the hookup instructions in this owner's manual. Any questions should be directed to your local ZAPCO dealer.

Caution: Continuous exposure to excessive sound pressure levels may cause permanent hearing loss. ZAPCO strongly advises that you use common sense when setting volume levels. If you experience ringing in the ears, it could cause permanent hearing damage!

Planning your power connections

The power end plates of the Zapco Z-series amplifiers carry the power connections and the Speaker connections and vary somewhat by the number of channels. For example, the power end of the Z-150.6 II has (of course) Speaker connections for six channels. One model, the Z-150.2 II has on-board fuses, while all other models will require an in-line fuse. Please follow the rating guidelines as in the Specifications page at the end of this manual.

That said, the main 12-volt power input, the 12-volt turn-on wire, and the main Ground connections are common to all models.

- The connection at the interior of the end plate is the main power input. This must be connected to the vehicle battery's positive (+) terminal, and a main system fuse should be placed close to the battery
- The connection at the outside of the end plate is the main ground or negative connection. This must be securely attached to bare metal at the vehicle frame, or other heavy chassis component with a direct connection to the frame

Note: Seat bolts and seat belt bolts are **NOT** good ground points

- The small terminal between the main power and ground is the +12 turn-on input and can be connected to the head unit turn-on output wire. If none is available it can be connected to an accessory (ACC) terminal. You should avoid using any ignition-on (IGN) wire, as they can be noisy

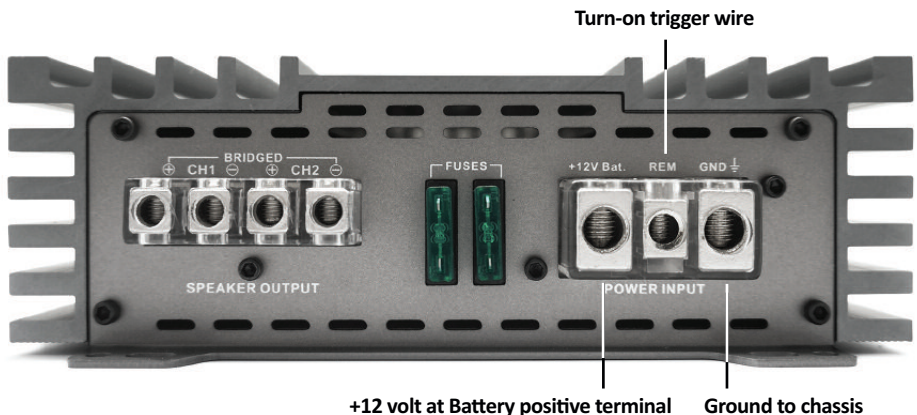

Note: The Z-Series amplifiers have terminals that do not require connectors. You simply insert a bare portion of wire and tighten the connection with the supplied Hex tool. As the wire conforms to the connector the connection can loosen. You should re-tighten the connection after about a week.

Some words about Power and Ground

Note: The second most common cause of underperforming amplifiers is insufficient power current or a poor power connection. The most common cause of underperforming amplifiers is insufficient ground current or a bad ground connection.

12-volt current: Battery Power works only if it travels in a complete circuit from the battery positive terminal to the battery negative terminal. Main power input, of course, is attached to the battery positive terminal. Ground current is returned to the battery through the chassis to the point where the battery is grounded.

The current available for your amplifier to use to produce power will be restricted by the smallest gauge of wire in the circuit and by the weakest physical connection in the circuit.

Wire Size

It's often surprising how many people will obsess about signal wire but routinely provide the amplifier with only a fraction of the current it needs to do its job. The most common wire gauge used in car audio is 10-gauge, and the most common location for amplifiers is in the trunk.

Wire Sizing Chart

	←----- Length of Run -----→							
	4 ft	7 ft	10 ft	13 ft	16 ft	19 ft	22 ft	28 ft
0-20 amps	14	12	12	10	10	8	8	8
20-35 amps	12	10	8	8	6	6	6	4
35-50 amps	10	8	8	6	6	4	4	4
50-60 amps	8	8	6	4	4	4	4	2
65-85 amps	6	6	4	4	2	2	2	0
85 -105amps	6	6	4	2	2	2	2	0
105-125 amps	4	4	4	2	2	0	0	0
125-150 amps	2	2	2	2	0	0	0	0

Let's look at a fairly small system. If you use a 50 watt/ch amp (25 amps) for the highs and a 100 watt/ch amp (40 amps) for the woofers, you need at least a 4-gauge and maybe a 2-Gauge wire to provide 65 amps at the trunk. Anything less and your car won't go boom. It'll just go Blap!

Note: It takes lots of current to make lots of power!

Remember! An electrical circuit is just that... a complete circuit. For current to travel, you must complete the circuit from the positive terminal to the negative terminal (which is connected to the vehicle frame). So what ever Gauge wire you use for power (B+) you must also use for ground (B-).

Note: A 4-gauge power wire needs 4-gauge ground wire!

Use the Wire Sizing Chart! Add up the fuse values on the amplifier(s) then choose the proper size wire based on the distance from the car battery to the amplifier location. Again, always use the same gauge wire for the main ground as you do for the main power. Always make your ground as short as possible and secure it to a clean solid surface, preferably the vehicle frame.

Mounting your Z-II Series amplifier

Mounting your Zapco amplifier is easy. Just keep in mind a few guidelines:

- The amplifier can be mounted in any direction, on wood, metal, or carpet
- The metal chassis of the amp can be grounded or left isolated
- The amplifier requires adequate ventilation. Creating power creates heat, and cooling requires air. Position the amplifier with sufficient surrounding area for air supply and keep the end plate and side vents clear for internal cooling
- Keep the amplifier out of the engine compartment or other locations that may cause excessive heat or moisture
- Do not mount the amplifier to a subwoofer box or other place that may have excessive vibration

Setting Gains: Gain pots are not volume controls. Before you first turn on your system, you should make sure all gain controls are set to minimum. Gain controls should be used only if absolutely necessary. Turning up gain controls causes increased noise, makes distortion more likely and reduces the dynamic range of your system. If you head unit does not have sufficient output, you will get much better results by investing in a line driver to provide more signal to the amplifier.

Z-150.2 II Input Ends

The Input ends of the Z-II amplifiers is where you find the signal input connectors and the various controls. All the Z-II amps have the same basic functions, adapted slightly to fit the expected use of each model.

We look first at the stereo (2-Channel) amp. The 550 watt (Bridged @ 4Ω) Z-150.2 II. Then we will look at the 4-Channel and 6-Channel models to see how they adapt to multichannel configurations.

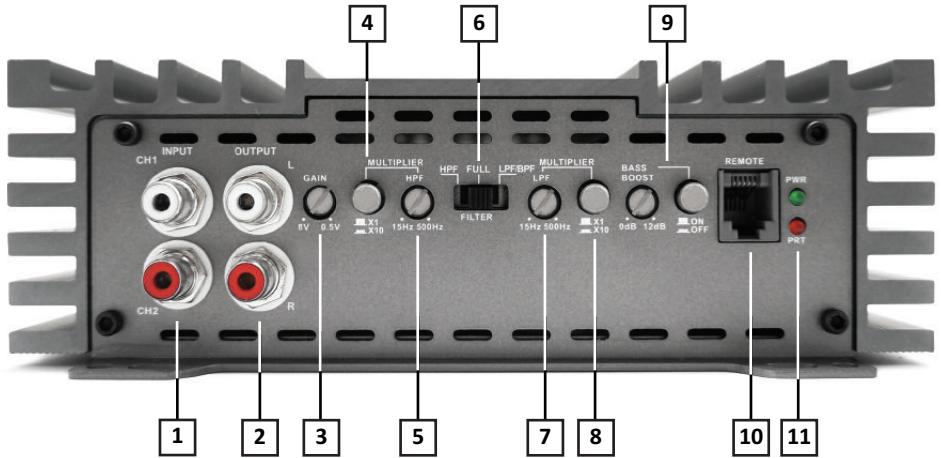

- 1• Right and left RCA input connectors using Zapco's proprietary connectors
- 2• To ease multi-amp installations, the amps have pass-through RCA outputs so you can "daisy-chain" multiple amps while only running one front-to-back RCA
- 3• Variable gain control
- 4• A unique feature of the crossovers is the Multiplier X10 switch that allows accurate frequency setting by changing the crossover range from 15Hz~500Hz to 150Hz~5000Hz. This is so you can use the amp full range, as a mid range (band-pass), or even as a tweeter amp
- 5• The high-pass (HP) crossover frequency selector

- 6• The Crossover function switch: To the left the switch is in high-pass mode, in the center the crossover is out of the signal path (full-range), to the right both filters are in the circuit so you can band-pass. If you are using the amp for bass the LP will be your sub crossover while HP filter will be a variable sub-sonic filter as low as 15Hz
- 7• The low-pass (LP) frequency selector
- 8• The X10 switch for the LP filter
- 9• Variable bass boost control from 0dB~12dB
- 10• Port for the optional bass control
- 11• The power on (green) LED and the protect (red) LED

Note: If you are using an amp for a band-pass midrange, the HP filter will be the lowest frequency of the band and the LP filter will be the top of the band. This passes all the frequencies between them. If you reverse the filters you will have no sound.

Z-150.4 II Input Ends

The Z-150.4 II is the 4-Channel amp and has the same basic controls and features as the 2-Channel amps but adapted for 4-channel use.

- The front channels do not have a low pass filter as they will be used either full range or for mids/highs or even tweeters
- The rear channels have exactly the same controls as the 2-Channel amps as the rears will be used as full-range or bass, depending on the application, or even band-pass if the amp is used for tweeters (Ch1/2) and mid-range's (Ch3/4)
- The Z-150.4 II adds a 2Ch/4Ch switch so you can choose to have only the Ch1/2 inputs feed both front and rear

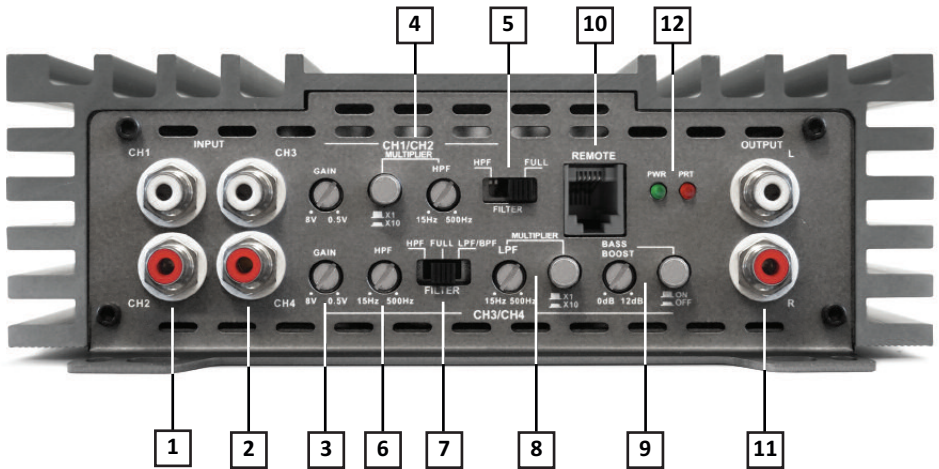

- 1**• Front (Ch1/2) RCA inputs
- 2**• Rear (Ch2/4) RCA inputs
- 3**• Front and rear variable gain controls
- 4**• Front (Ch1/2) Multiplier and HPF frequency control*
- 5**• Crossover mode select (Clone position makes both front and rear crossovers identical)
- 6**• Rear (Ch3/4) HPF frequency control
- 7**• Rear crossover mode switch*
- 8**• Rear (Ch3/4) Multiplier and LPF frequency control*
- 9**• Variable Bass boost control
- 10**• Port for optional dash mount bass gain control
- 11**• Auxiliary pass-through RCA output*
- 12**• Power and Protect LEDs

* See explanations of these functions on the previous section 2-Channel amps

Z-150.6 II Input Ends

The Z-150.6 II is the 4-Channel amp and it also has the same basic controls and features as the other amps but has been adapted for 6-channel use.

- The channels 1/2 do not have a low-pass filter as they will be used either full range or for mids/highs so there is only high pass here
- Channels 3/4 have high pass, full range, and low pass positions so they can be used for highs, or they can be band-passed for mid-range use
- Channels 5/6 do not have a crossover function switch as they are band pass only. They can be used as the bass section with the low-pass and a variable sub sonic. The sub sonic (which is high-pass), however has a wide frequency range so it can be used as the bottom of a band-pass to drive mid-bass drivers, if you have a separate sub amp
- The input mode switch lets you use 2Ch, 4Ch, or 6Ch of input, so you can drive all the channels from a single 2Ch stereo output from a head unit

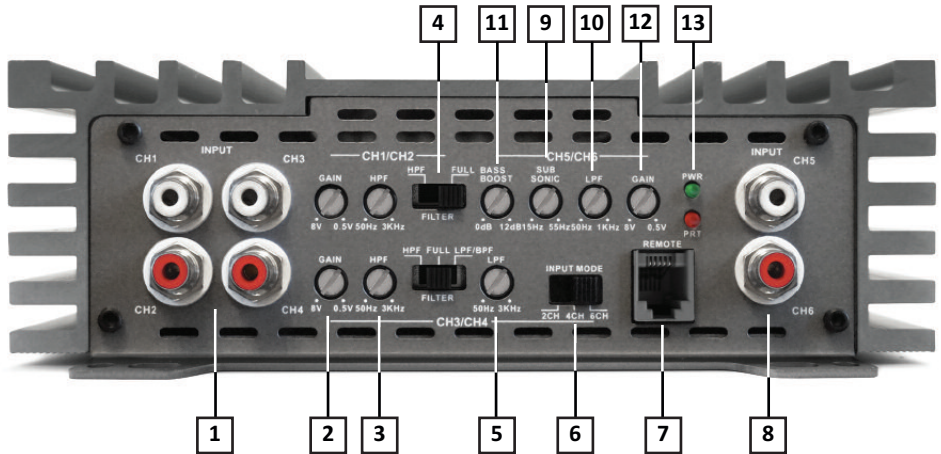

- | | |
|---|---|
| 1• Ch1/2 and Ch3/4 RCA Inputs | 7• Port for optional dash remote |
| 2• Ch1/2 and Ch3/4 variable gain controls | 8• Ch5/6 RCA inputs |
| 3• Ch1/2 and Ch3/4 HPF frequency controls | 9• Ch5/6 Sub sonic (HP) frequency control |
| 4• Ch1/2 and 3/4 crossover mode switches | 10• Ch5/6 LP bass crossover frequency control |
| 5• Ch3/4 LPF frequency control | 11• Variable bass boost control |
| 6• Input mode for 2Ch, 4Ch, or 6Ch inputs | 12• Ch5/6 variable gain control |
| | 13• Power and protect LEDs |

* See explanations of common functions on the previous sections

Speaker Wiring of the Z-II Class AB Amplifiers

The Very Basics

- No speaker wires can be shorted to, or touching either ground or each other. This will put the amp into protect and may damage the amplifier
- When bridging the left and right channels of any amplifier, you use the left channel (Ch1) positive and the right channel (Ch2) negative, as indicated on the chassis by the speaker terminals

Z-150.2 II Speaker Wiring

Stereo Mode

- Commonly a pair of full range speakers with x10 swt. off (out or x1 position) and HPF set between 70Hz~100Hz to protect the speakers from deep bass.
- To use for tweeters put Multiplier switch to x10 (pushed in) and set HPF between 2000Hz~5000Hz, as per the tweeter makers recommendation
- To use for midrange: Determine the range of frequencies you want. Put the LPF/BPF Multiplier switch to x10 (pushed in) and set the LPF filter to the highest frequency you want to have. Set the HPF filter to the lowest frequency you want to have

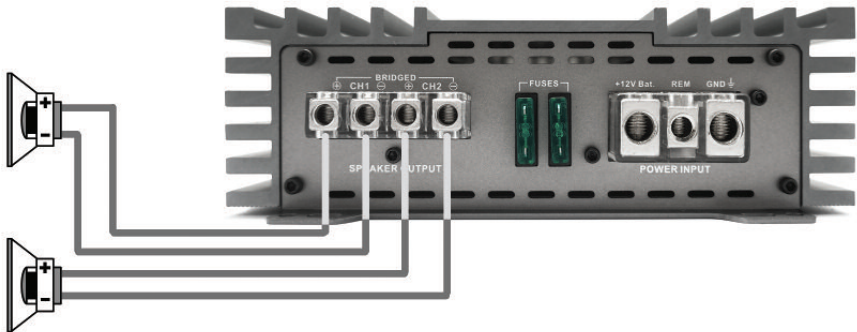

Single Channel Mode

Bridged to one voice coil using L+ and R-

- Commonly for a woofer. Set crossover mode to LPF/BPF with Multiplier to off (x1)
- Set LPF freq. to woofer maker's recommendation. Set HPF crossover freq. to 20Hz to use as a sub sonic filter

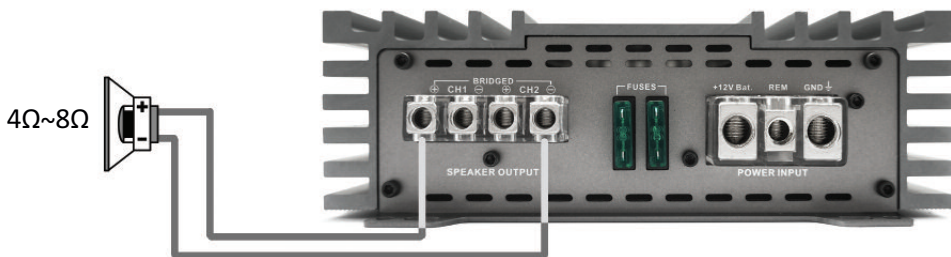

Note: Take note that 4 Ohms is the minimum load when bridging, since each channel will see only 1/2 the load (2 ohms). Do not bridge with a 2Ω woofer

3Ch Mode

It is possible to run the 2-Channel amps in “3-channel” mode by running a pair of speakers for the mids and highs on left and right channels, and at the same time run a woofer bridged between the L+ and R- terminals as shown. However, since each channel will see 1/2 the impedance of the woofer you must use a woofer of no less than 4Ω. The amplifier sees impedance by frequency, so you can have two 2Ω loads but you must use a passive crossover on each speaker in the three channel mode. With the crossovers in the line, the amplifier will always see a minimum load of 2Ω on each channel at all frequencies.

- Main speakers can be 2Ω~4Ω
- Woofer can be 4Ω~8Ω but cannot be less than 4Ω
- HP crossover can be FULL or can be HPF to be used between 15Hz and 25Hz as sub sonic filter
- LP crossover must be set to FULL
- All actual crossover functions will be done by the passive crossovers in the lines

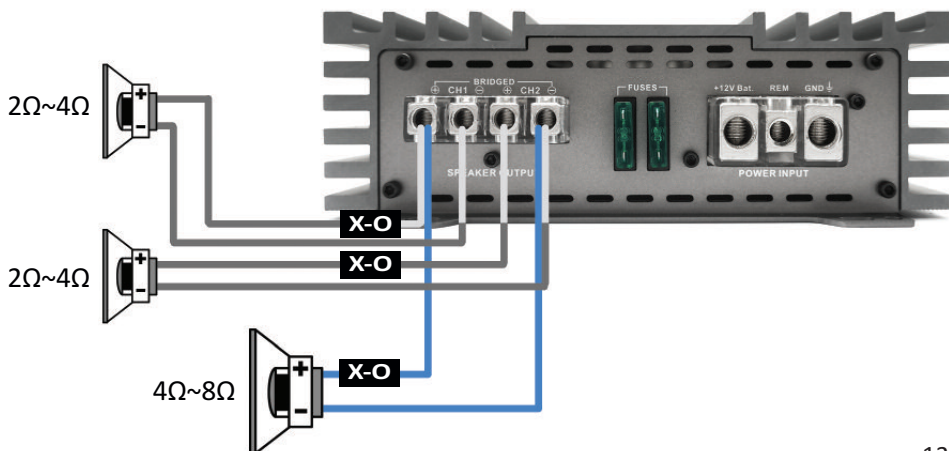

Z-150.4 II Speaker Wiring

Standard 4Ch Mode

The Z-150.4 II four channel amplifier is virtually two 2Ch amps in one chassis and each set of four speaker terminal can be used exactly as you would use a 2Ch amp. The advantage of a four channel amp is primarily the saving of ace (and a little money). Using a four channel also reduces the installation work, over installing two 2Ch amps. This is especially so with some of the unique features of the Z-Series amps.

- This is the standard hookup for full range front and rear speakers
- Speakers can be $2\Omega\sim 4\Omega$
- If the head unit has 2 sets of RCA outputs you will be able to fade front to rear
- You don't have to use crossovers, but it's wise to use the HPF filters set to 30Hz or a little more as a sub sonic filter to protect the speakers. Best policy is to check your speakers frequency range. Set the sub sonic (HP) frequency just a little above to lowest of the speakers frequency range. i.e. If the speakers range is 40Hz~18,000Hz set filter to 45Hz. The LPF switches should be in FULL
- The HPF Multiplier (x10 switch) must be in the off or x1 position

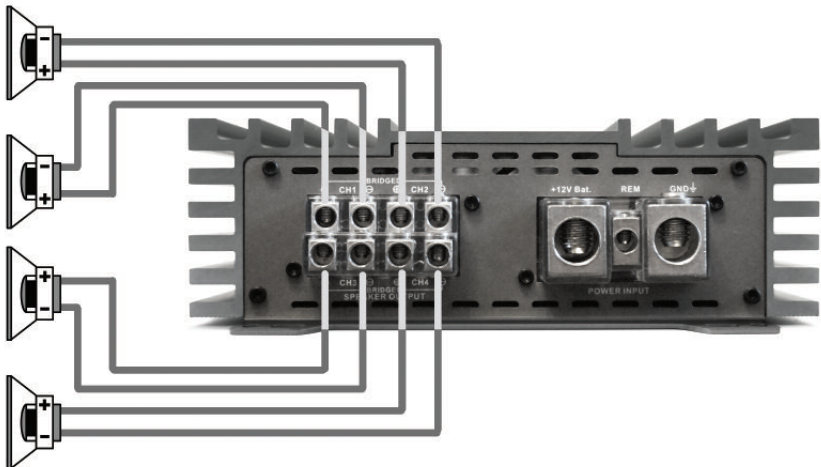

4Ch 2-Way Mode

With the unique features of the Z-Series amplifiers you can also use the Z-150.4 II to drive a 2-way system with the front channels for highs and the rear channels for lows. The unique crossover will let you separate high and low like most 4Ch amps, but with the added range provided by the multiplier (x10) switch you can actually have a tweeter crossover as high as 5,000Hz on the front channels. With the series' band-pass functions, you can have the rears play everything below the tweeters, or you can have the rears play only midrange and use a separate amp for your subs.

For the diagram below of an active 2-way system:

- Front (1/2) crossover is set to HPF and multiplier switch set to x10 (in). HP frequency is set to the tweeter's recommended cut-off point (usually between 2KHz and 5KHz)
- Set the rear filter to LPF/BPF so both the rear filters are active
- Set the LPF/BPF multiplier switch to x10 (in) and set the frequency to the same frequency that was used on the tweeter high-pass filter
- If the lows speaker will be used as woofers then set the rear (3/4) HPF to around 30Hz as a sub sonic filter
- If another amp will be used for bass and channels 3/4 will be used a midrange, then set the rear HP filter to the frequency where the woofer will begin operating (usually 80Hz~120Hz)

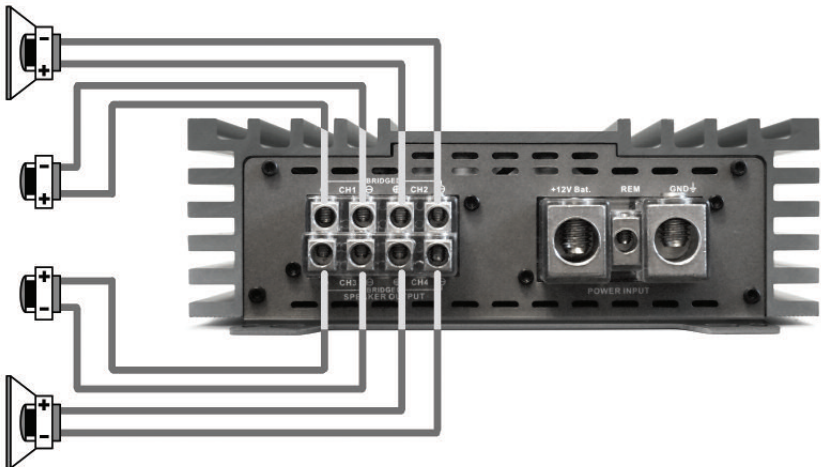

2-Way w/Bridged Mono Sub

A similar setup uses a pair of full-range speakers with a mono subwoofer.

- Front filter is set to HPF, the Multiplier is off (out), HP frequency is set just above the bottom of the full-range speaker's frequency range, where you will also set the woofer crossover
- Set the rear Filter to LPF/BPF to have both filters active and the multiplier to off (x1). Set the rear LPF frequency to the desired woofer crossover point (which should match the front high pass filter), and set the HPF frequency to 15Hz~30HZ as a sub sonic filter

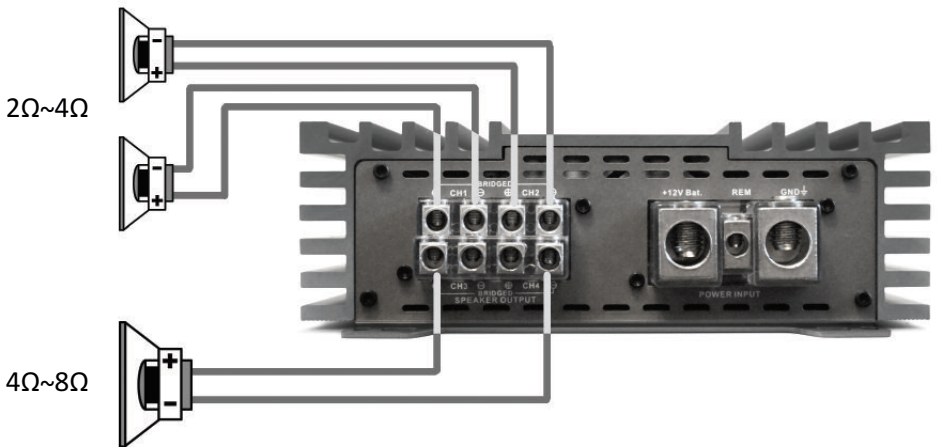

2Ch Bridged

Want more power? Instead of four channels of 165 watts, you can have two channels of 550 watts each by bridging both front and rear amp sections to one speaker each.

- Speakers must be a minimum of 4Ω impedance
- Using RCA "Y" adaptors of 1 female-to-2 male, put the left signal RCA into both L and R inputs of the front channels and put the right signal RCA into both L and R inputs of the rear channels
- Do not use the optional dash bass control as it will only work on the speaker connected to the rear channels

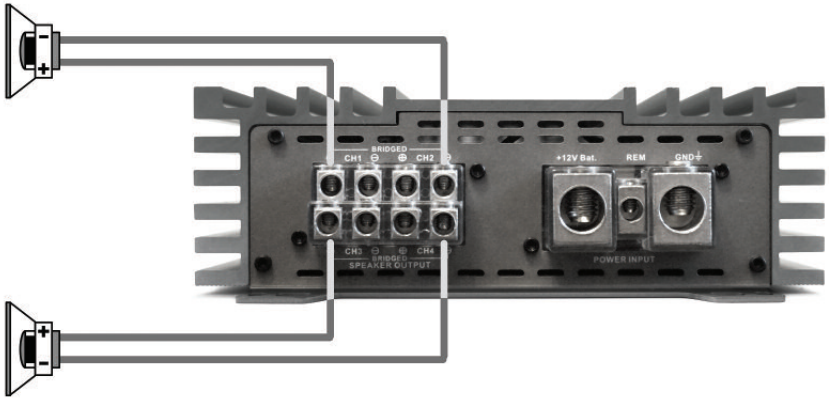

Z-150.6 II Speaker Wiring

6 Ch 6 speakers

The Z-150.6 II is a 6-channel amp that can drive six speakers from 6, 4, or 2 channels of input. Note that channels 5 and 6 are arranged top and bottom and CH5 has + and - reversed from the other channels.

That said:

- If you are driving full range speakers the only control you will really need is on Channels 1-4 are the HPF filter to use as a sub sonic. Channels 5 and 6 are designed for bass or mid-bass and plays from 15Hz to 1000Hz

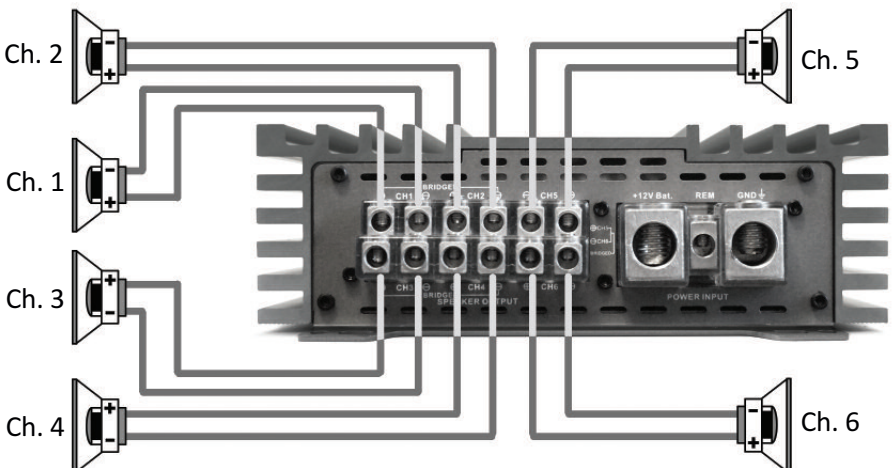

A One-Amp, Active 3-way System

The Z-150.6 II is a superbly versatile piece of gear. With the crossover features of this amp you can run a completely active 3-way system. You can run it as Tweeter , midrange, bass. You can also ruin it as tweeter, band-passes mid-range, and band passed mid-bass and then use a separate subwoofer amp. Below is an active 3-way system using a mono bass driver.

- The Input Mode switch can be set for 2,4,or 6 channels of input, but setting up a 3-way system is best done with a 2-channel input unless you are using a digital processor ahead of the amp
- Ch1/2 are used for tweeters. The multiplier is set to x10 (pushed in) with the Filter switch set to HPF. The HP frequency is set to tweeter's recommended HP range (usually between 2kHz~3kHz)
- Ch 3/4 are mid-range. The Ch3/4 Filter switch is set to LPF/BPF so both filters are active. The HP frequency should be set to the frequency that the woofer will begin (usually between 80Hz~120Hz). The Ch 3/4 LP frequency is set to the same frequency as the tweeter HP frequency (usually 2kHz~3kHz) that was set in the previous step
- Ch 5/6 are bridged for a mono woofer. Ch 5/6 always have both filters active. Set the LPF frequency to the same frequency as the Ch3/4 high pass filter, so the top of the woofer is the bottom of the midrange
- The bass boost should only be set after system is installed and you have had a chance to listen to see if any bass boost is needed

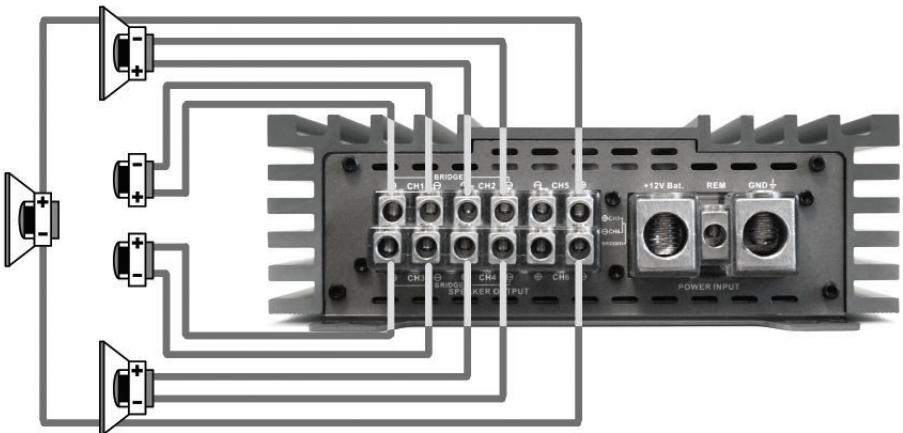

- Speakers on channels 1~4 must be minimum 2Ω of higher
- The bridged woofer must be 4Ω of higher
- You can add the optional dash control for the bass channels 5/6

High Power 2-way System

The system below provides plenty of power for a 2-way active system with even the lowest efficiency front speaker system. Each speaker has 550 watts RMS @ 4Ω

- Since all speakers are being bridged, they must all be minimum 4Ω~8Ω impedance
- Ch1/2 and 3/4 will use Filters set to HPF with frequency set to where the woofer will begin
- Ch5/6 will use the HP Sub Sonic filter at 15Hz~30Hz to protect the woofer. The low-pass filter should be set the HP frequency of the full-range speakers on Ch1/2 and Ch3/4

It is critical the crossover frequencies and gains of Ch1/2 and Ch3/4 are set exactly the same.

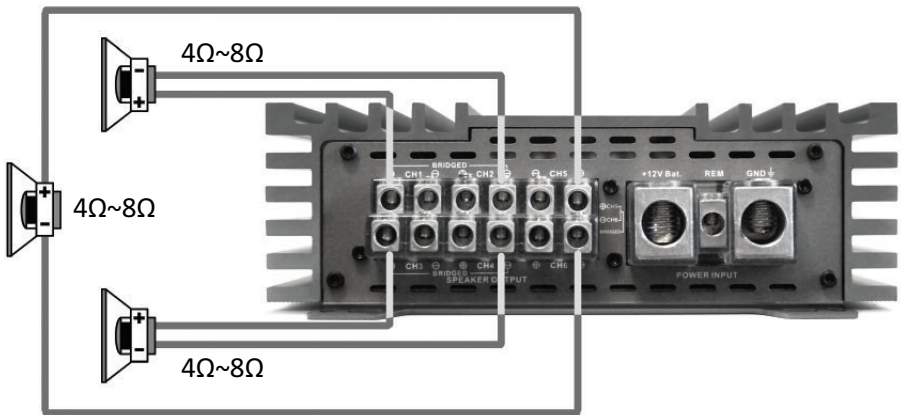

This same setup can also be used for a high power Left, Center, Right front stage.

Z-KD II Input Ends

The Z-1KD II, Z-2KD II, and Z-3KD II share the same endplates and the same controls. The controls of these amps are designed specifically to allow you to maximize the bass performance of your system.

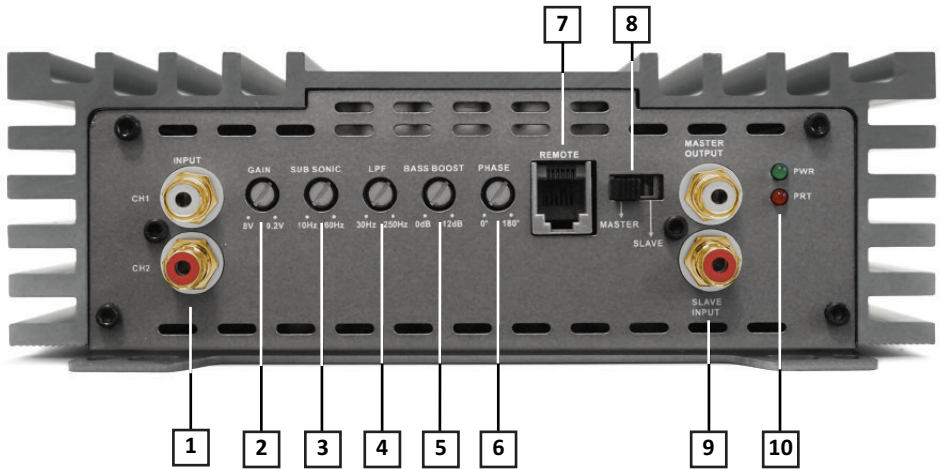

- 1• RCA Inputs
- 2• Gain/Sensitivity control
- 3• Sub Sonic Filter to protect woofers
- 4• Frequency control for the Low Pass Crossover
- 5• Variable Bass Boost
- 6• Variable Phase Control
- 7• Port for the optional Dash Bass Control
- 8• Master/Slave Switch (See next page about "strapping amplifiers")
- 9• RCAs for Master Output and Slave Input
- 10• The power on (green) LED and the protect (red) LED

Notes on the Mono Bass Amp controls:

- **Strapping** - Two Z-II mono bass amps can be bridged together to operate a single voice coil (speaker) giving it roughly twice the power of a single amplifier. When two amps are "strapped" the Master amp's controls will control crossover, sub sonic, bass boost etc. of both amps. When strapping the amps you must maintain a minimum load of at least 2 Ohms

See the input wiring diagram Below:

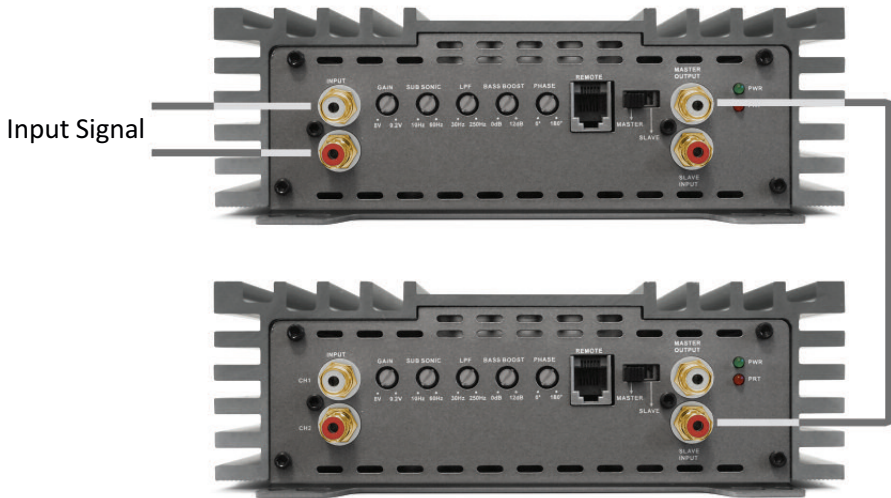

The Master amp receives the input signal for both amps. With the switch in "master", it sends the proper signal to the slave amp. The ONLY control used on the slave amp is the master/slave switch which is put into the slave position. These two amps will now act as one. See the next section for the speaker wiring.

- **Sub Sonic** - This filter is there to protect the woofer from frequencies that can hurt it. Generally for large woofers in sealed boxes this can be set at about 25 to 30 Hz. The sub sonic becomes most critical when used with a ported box. The sub sonic should be set just below the port frequency regardless of the woofer
- **Phase** - The phase control will help blend the woofer with the rest of the system

Speaker Wiring of the Z-II Class D Bass Amplifiers

Speaker wiring is identical for all three Z-II Class D amps:

There are four connections for speakers, but note that the 2 left hand terminals are both positive and the two right hand terminals are both negative. This is to make hooking up multiple woofers easier. For a single woofer you use one of the positive terminals and one of the negatives.

Z-KD II Speaker Wiring

One speaker hookup

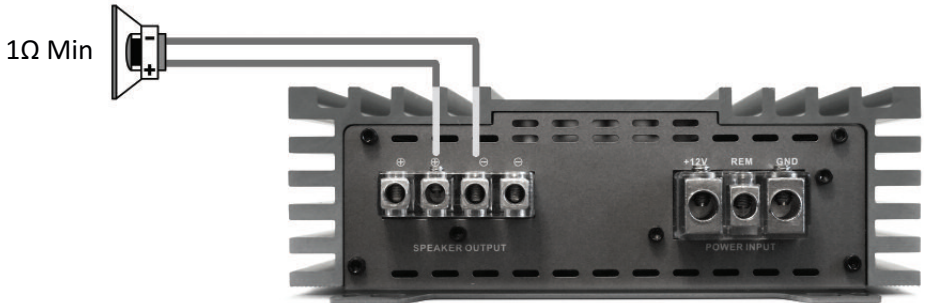

Two speakers hookup

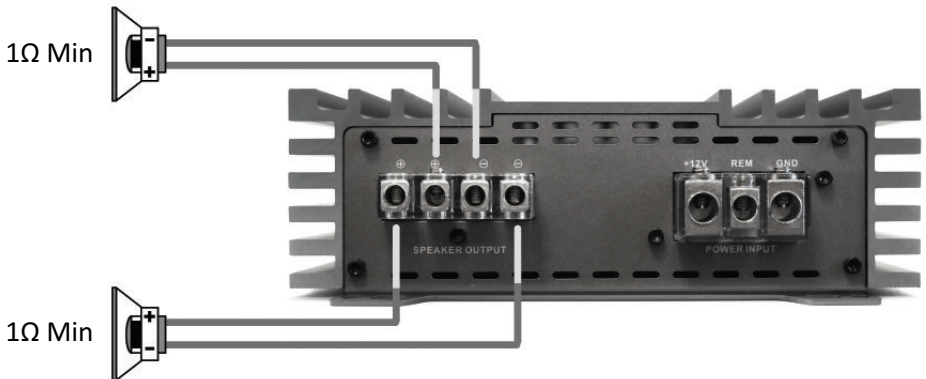

Strapping two amps to one speaker voice coil

When you strap two amplifiers together, you are using one amp for the positive side of the signal and one amp for the negative side. Internally this is accomplished by reversing the polarity (or phase) of the input to the slave amp.

After strapping, each amplifier will see 1/2 of the load. Since the minimum load of each amp is 1Ω , the minimum load for the PAIR of amplifiers is 2Ω . You must not strap 2 amps to a 1Ω load.

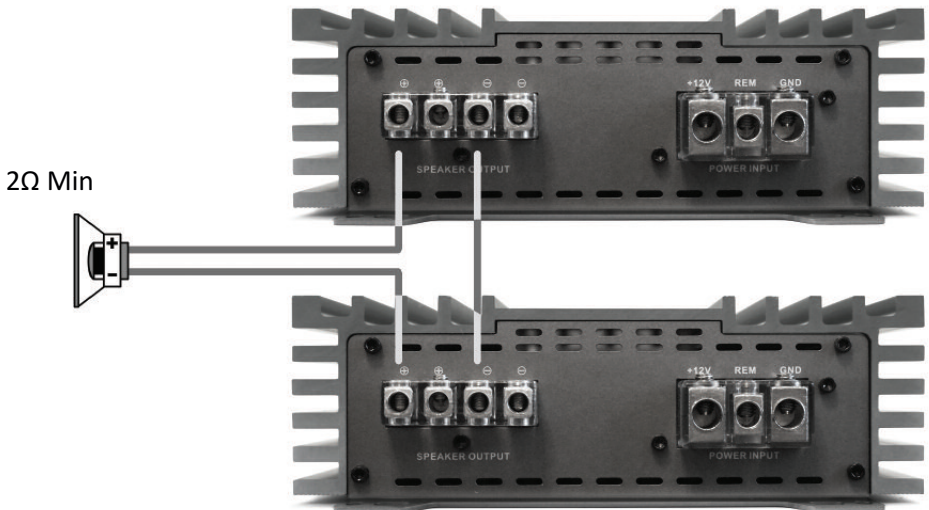

The positive of the master amp goes to the + Speaker terminal and the positive of the slave amp goes to the - speaker terminal. The amps are connected together by connecting a negative terminal from the master amp to a negative terminal of the slave amp

Technical Specifications



Z-150.2 II

Power @ 4Ω: 2 x 165 watts
 Power @ 2Ω: 2 x 275 watts
 Power @ 4Ω Bridged: 1 x 550 watts
 THD @ Rated Power < 0.1%
 Signal to Noise Ratio > 100dB
 Channel separation > 60dB
 Freq. Resp. 10Hz to 30,000Hz ±1dB
 Input Sensitivity .25v to 8v
 Dim. in mm: 190(W) x 62(H) x 301(L)
 Overall: 190(W) x 62(H) x 328(L)
 Fuse: 2 x 30A fast blow



Z-150.4 II

Power @ 4Ω: 4 x 165 watts
 Power @ 2Ω: 4 x 275 watts
 Power @ 4Ω Bridged: 2 x 550 watts
 THD @ Rated Power < 0.1%
 Signal to Noise Ratio > 100dB
 Channel separation > 60dB
 Freq. Resp. 10Hz to 30,000Hz ±1dB
 Input Sensitivity .25v to 8v
 Dim. in mm: 190(W) x 62(H) x 444(L)
 Overall: 190(W) x 62(H) x 479(L)
 Recommended fuse: 80A fast blow



Z-150.6 II

Power @ 4Ω: 6 x 165 watts
 Power @ 2Ω: 6 x 275 watts
 Power @ 4Ω Bridged: 3 x 550 watts
 THD @ Rated Power < 0.1%
 Signal to Noise Ratio > 100dB
 Channel separation > 60dB
 Freq. Res. 10Hz to 30,000Hz ±1dB
 Input Sensitivity .25v to 8v
 Dim. in mm: 190(W) x 62(H) x 573(L)
 Overall: 190(W) x 62(H) x 614(L)
 Recommended fuse: 100A fast blow



Z-1KD II

Power @ 4Ω: 450 watts
 Power @ 2Ω: 700 watts
 Power @ 1Ω: 1050 watts
 Power @ 2Ω Link: 1800 watts
 THD @ Rated Power < 0.05%
 Signal to Noise Ratio > 90dB
 Freq. Resp. 10Hz to 350Hz ±1dB
 LP freq. crossover: 30Hz~250Hz
 Input Sensitivity .25v to 8v
 Phase shift control: 0~180°
 Subsonic filter: 10Hz~60Hz
 Bass boost @ 45Hz: 0~12dB
 Dim. in mm: 190(W) x 62(H) x 275(L)
 Overall: 190(W) x 62(H) x 305(L)
 Recommended fuse: 100A fast blow

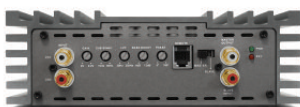

Z-2KD II

Power @ 4Ω: 800 watts
 Power @ 2Ω: 1400 watts
 Power @ 1Ω: 2100 watts
 Power @ 2Ω Link: 3600 watts
 THD @ Rated Power < 0.05%
 Signal to Noise Ratio > 90dB
 Freq. Resp. 10Hz to 350Hz ±1dB
 LP freq. crossover: 30Hz~250Hz
 Input Sensitivity .25v to 8v
 Phase shift control: 0~180°
 Subsonic filter: 10Hz~60Hz
 Bass boost @ 45Hz: 0~12dB
 Dim. in mm: 190(W) x 62(H) x 450(L)
 Overall: 190(W) x 62(H) x 486(L)
 Recommended fuse: 200A fast blow



Z-3KD II

Power @ 4Ω: 900 watts
 Power @ 2Ω: 1800 watts
 Power @ 1Ω: 3000 watts
 Power @ 2Ω Link: 6000 watts
 THD @ Rated Power < 0.05%
 Signal to Noise Ratio > 90dB
 Freq. Resp. 10Hz to 350Hz ±1dB
 LP freq. crossover: 30Hz~250Hz
 Input Sensitivity .25v to 8v
 Phase shift control: 0~180°
 Subsonic filter: 10Hz~60Hz
 Bass boost @ 45Hz: 0~12dB
 Dim. in mm: 190(W) x 62(H) x 620(L)
 Overall: 190(W) x 62(H) x 657(L)
 Recommended fuse: 300A fast blow



Modesto, California USA
Since 1974

zapco.com